

Section 5 Undercarriage & Suspension

Slider Body Rails



Part Number	Description
HUT12713-28	Slide Rail Hutch Style 208"
HUT16816-19	Slide Rail Hutch Style 216"
HUT16816-25	Slide Rail Hutch Style 240"



Part Number	Description
BINSLOA1203-09	Slide Rail Binkley Style 3.5" X 3.5" X 198"
BINSLOA1203-10	Slide Rail Binkley Style 3.5" X 3.5" X 204"
BINSLOA1203-13	Slide Rail Binkley Style 3.5" X 3.5" X 216"
BINSLOA1203-23	Slide Rail Binkley Style 3.5" X 3.5" X 276"



Part Number	Description
33032	Slide Rail Roadside & Curbside 108" Great Dane H-Slide (Rear Rail)



Part Number	Description
33034	Slide Rail Curbside 104" Great Dane H-Slide (forward Rail)
33035	Slide Rail Roadside 104" Great Dane H-Slide (forward Rail)

Section 5 Undercarriage & Suspension

Slider Tandem Stop Bars

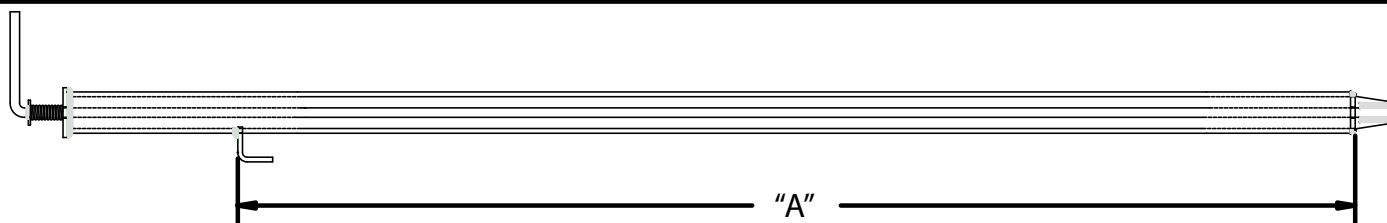

Part Number	Description	DIM "A"
31196	Tandem Stop Bar 1.66"OD X 52.00"	44.90"
32784	Tandem Stop Bar 1.66"OD X 58.00"	50.90"

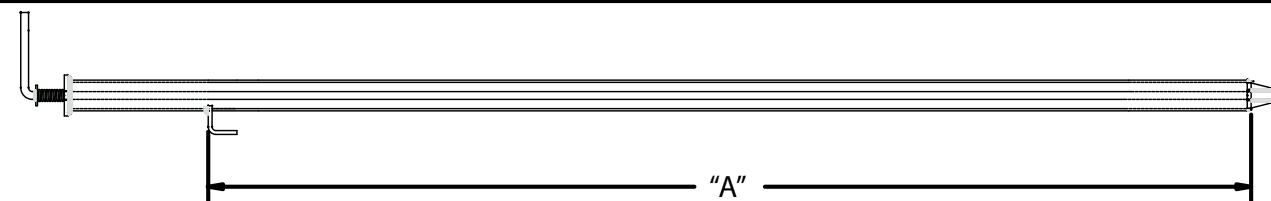

Part Number	Description	Dim "A"
33278	Tandem Stop Bar 1.50"OD X 52.00"	44.90"
33279	Tandem Stop Bar 1.50"OD X 58.00"	50.90"

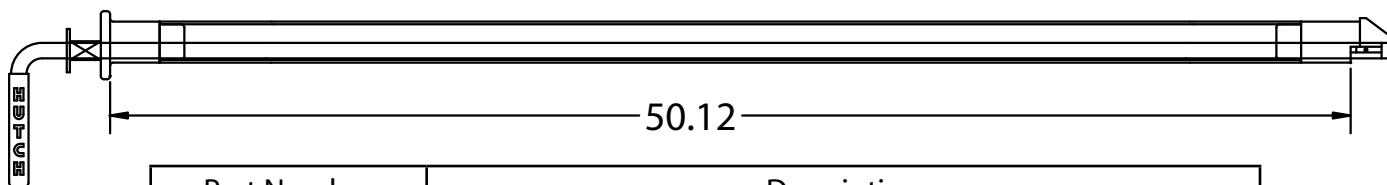

Part Number	Description
HUT11642-10	Tandem Stop Bar (Hutch)



Part Number	Description
HENS-14231-8	Tandem Stop Bar (Hendrickson) 102" Trailer



Part Number	Description
BINSL0502-48	Tandem Stop Bar (Binkley) 102" Trailer

Section 5 Undercarriage & Suspension

Slider Tie Down Clips



Part Number	Description
HENS-24460	Slider Hold Down Clip H9200 Series 4" Hole Centers



Part Number	Description
HUT12715-01	Slider Hold Down Clip H9200 Series 4" Hole Centers



Part Number	Description
HUT20289-01	Slider Hold Down Clip H9800 Series 2.25" Hole Centers



Part Number	Description
46675	Slider Hold Down Clip B-Slide (XB-SL0031)



Part Number	Description
HENS-14108	Slider Hold Down Clip Old Style 1.5" Hole Centers



Part Number	Description
HENS-22366	Slider Hold Down Clip New Style 2" Hole Centers

Section 5 Undercarriage & Suspension

Slide Pin Operating Rods

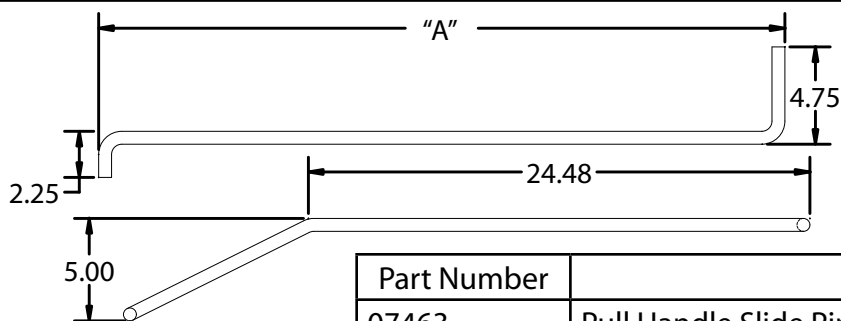

Part Number	Description	Dim "A"
07463	Pull Handle Slide Pin Release H-Style Bogie	30.50"
13409	Pull Handle Slide Pin Release H-Style Bogie	33.50"

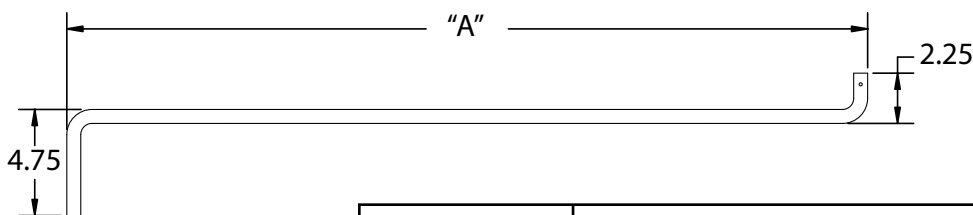

Part Number	Description	Dim "A"
16966	Pull Handle Slide Pin Release B-Style Light Weight Bogie	32.85"
16967	Pull Handle Slide Pin Release B-Style Light Weight Bogie	35.85"

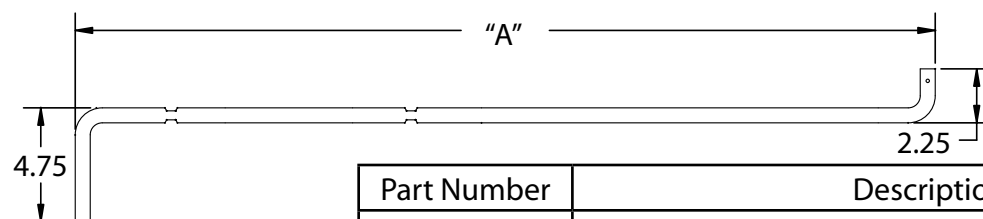

Part Number	Description	Dim "A"
42400132	Pull Handle Slide Pin Release Container Chassis	24.81"
42400902	Pull Handle Slide Pin Release Container Chassis	35.85"
40302101	Pull Handle Slide Pin Release	33.85"
40302102	Pull Handle Slide Pin Release	31.85"
40302103	Pull Handle Slide Pin Release	34.85"

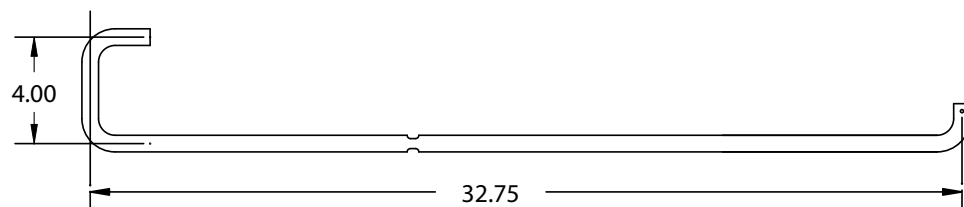

Part Number	Description
HUT12781-01	Pull Handle Slide Pin Release 32.75" Hutchens

Section 5

Undercarriage & Suspension

Slide Pin Operating Rods

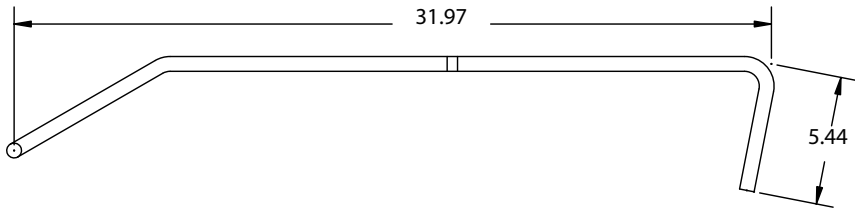

Part Number	Description
HUT18010-01	Pull Handle Slide Pin Release 31.96" Hutchens

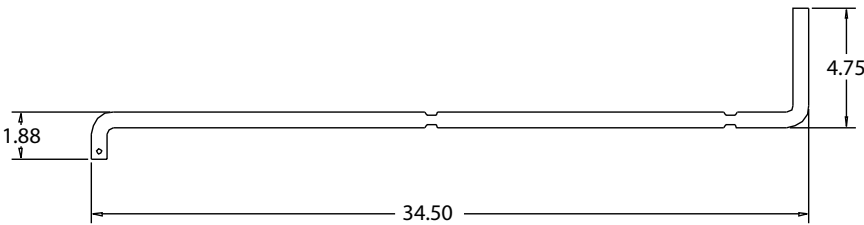

Part Number	Description
BINSL0744-07	Pull Handle Slide Pin Release Binkley

Quick Release



Part Number	Description
BINSL0724-42	Quick Release Pull Handle 96" Wide Trailer
BINSL0724-48	Quick Release Pull Handle 102" Wide Trailer

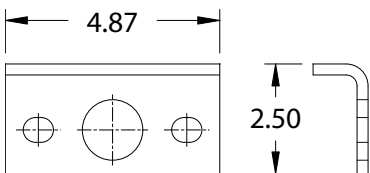

Part Number	Description
47396	Torsion Cam Quick Release SL0758-01-PTD

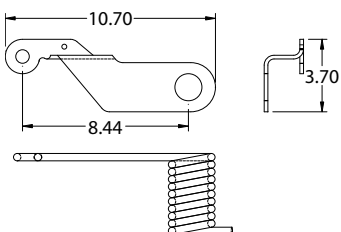

Part Number	Description
BINSL0019	Torsion Kit Quick Release (Lever & Spring)



Great Dane Trailers

Section 5 Undercarriage & Suspension

Quick Release

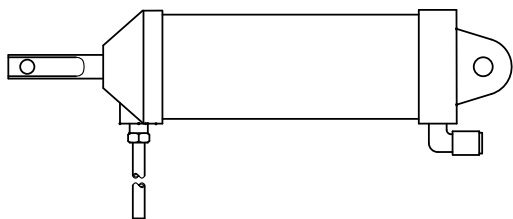

Part Number	Description
HUT19515-01	Cylinder P-3 Pin Puller (Hutch)

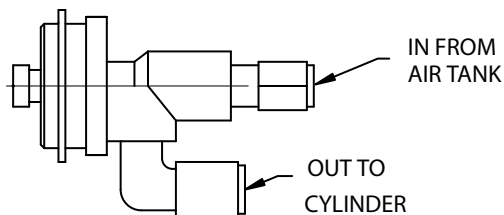

Part Number	Description
HUT17708-01	Valve for P-3 Pin Puller

Slide Rail Reinforcements



Part Number	Description
18335	Slide Rail Reinforcement 2.57" X 3.00"



Part Number	Description
40100294	Running Gear Rail Reinforcement B-Slide 2.75" X 5.00"



Part Number	Description
07870	Slider Stop Block 1.00" X 1.00" X 2.00"